

PROGRAM PRATO



VAL
OPRUGA



DRVENA
NOGICA



POMOĆNI
LEŽAJ

Elementi

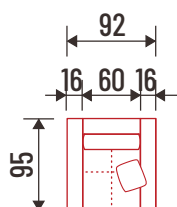

10
Fotelja
2R

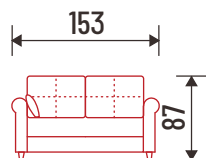
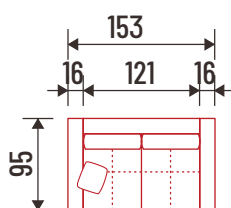
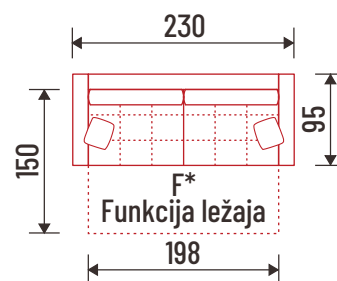
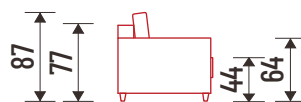

20
Dvosjed
2R

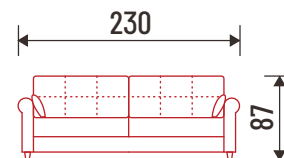
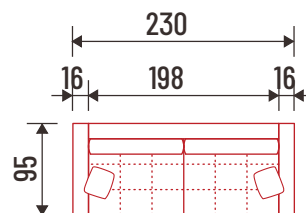

30F*
Trosjed
2R

Sastavi

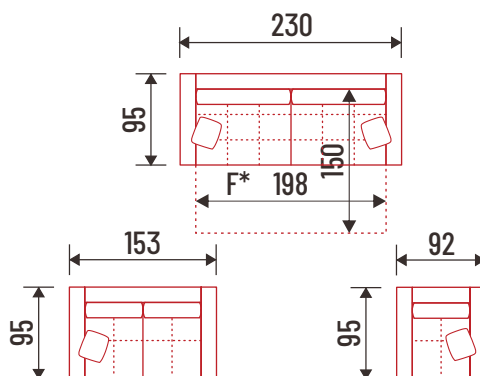

Sastav 03 (30F*-20-10)