

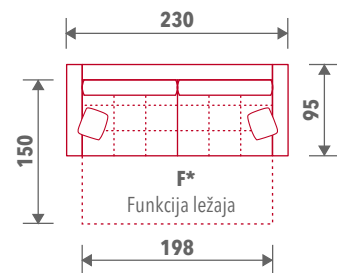

Elementi

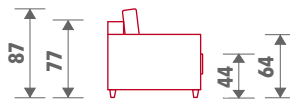

10
Fotelja
2R

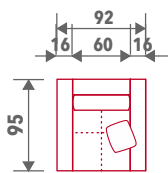
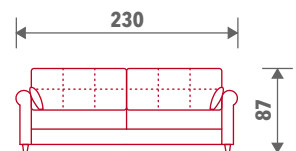
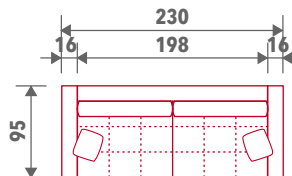
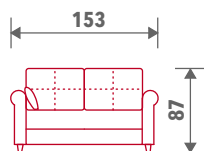
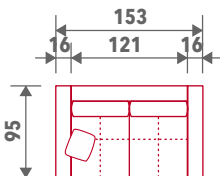

20
Dvosjed
2R

30F*
Trosjed
2R

Sastav

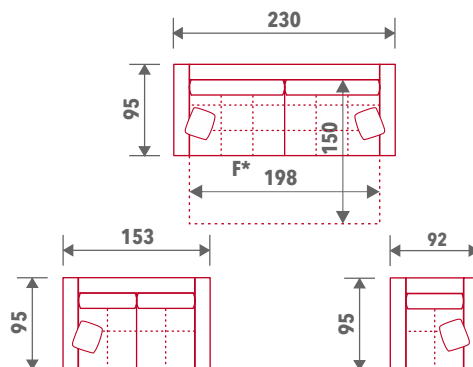

Sastav 03 (30F*-20-10)